

MK20.5.V1.25

PANO KAPAK MENTEŞESİ (Boyalı-Civatalı-h:25mm)
HINGE FOR PANEL COVER (Black Coated-With Bolt-h:25mm)



300Kg.

MK20.5.V2.25

PANO KAPAK MENTEŞESİ (Boyalı-Delikli-h:25mm)
HINGE FOR PANEL COVER (Black Coated-Hole-h:25mm)



300Kg.

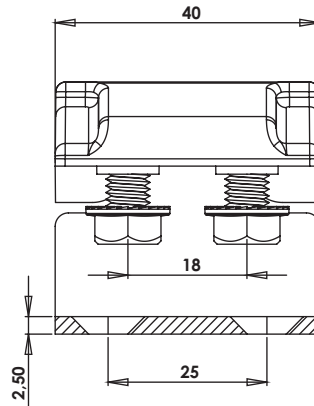
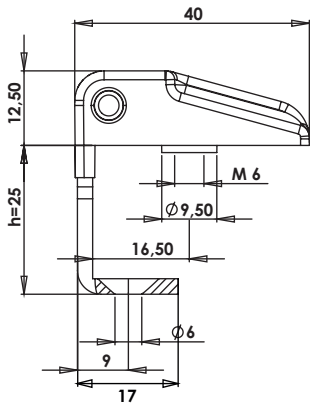
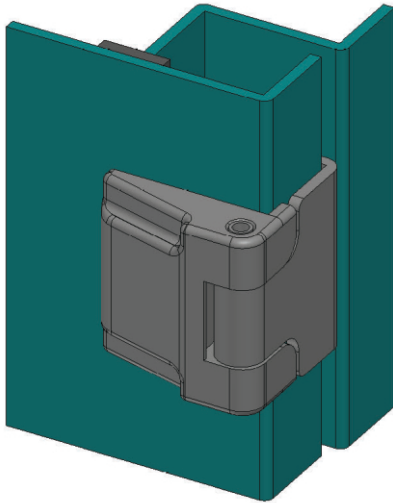
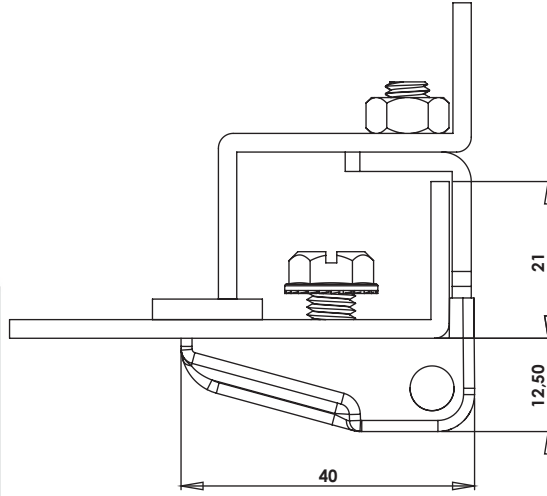
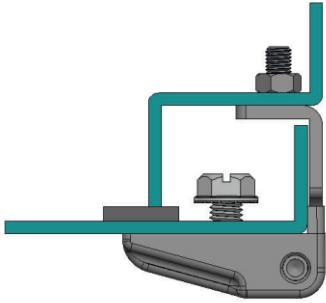
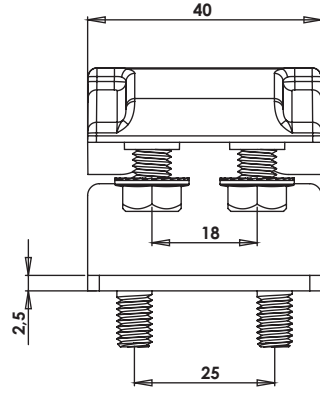
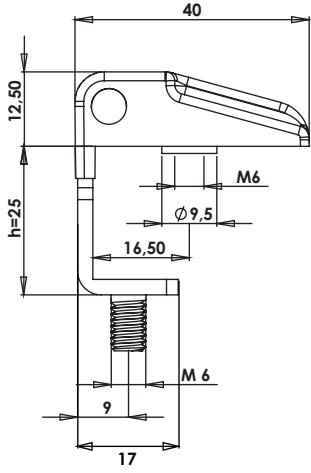

Kullanım Alanları

- * Elektrik Panoları
- * Makine Kapakları

Malzeme

- * Gövde: Zamak
- * DIN-EN 1774-ZnAl4Cu1
- * Kenar Parça :Çelik St 37
- * Pim: Çelik St 37
- * Civata: Çelik St 37
- * 5: Kaplama: Boyalı
- * Menteşe Dönme Açısı: 180°

Applications

- * Electric Panels
- * Machinery Covers

Material

- * Body: Zamak
- * DIN-EN 1774-ZnAl4Cu1
- * Welding Part : Steel St 37
- * Pin : Steel St 37
- * Screw: Steel St 37
- * 5: Finish: Black Coated
- * Hinge Rotation Angle: 180°