

KY69.K

MİNİ YAYLI PANO KİLİDİ (Segmanlı - Kelebek)
MINI QUARTER TURN WITH CLIPS - SPRING

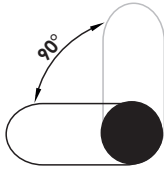

Anahtar Dönme Açısı
Key Rotation Angle

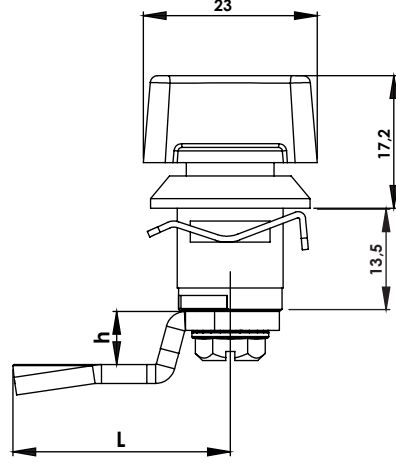
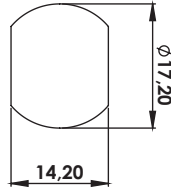

Geçiş Ölçüsü
Cut Out

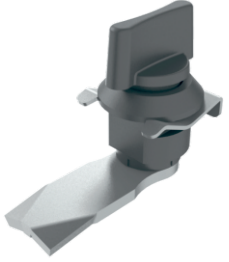
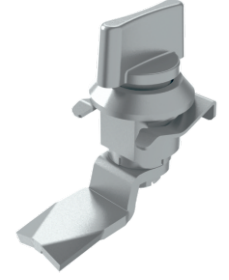
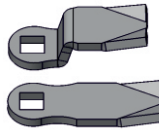
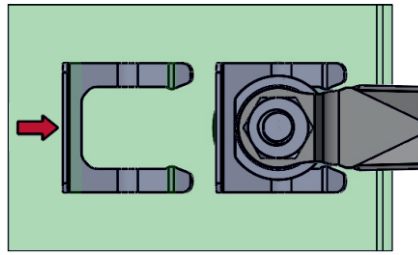
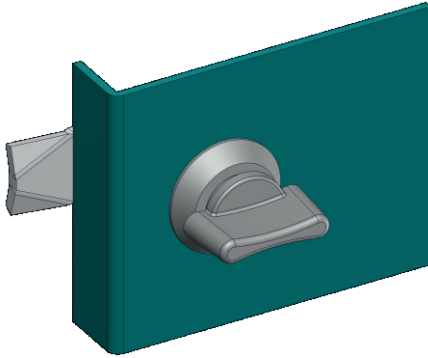

Kullanım Alanları

- * Elektrik Panoları
- * Makine Kapakları

Malzeme

- * 1: Gövde: Zamak
DIN-EN 1774-ZnAl4Cu1
- 35: Gövde : Polyamide
DIN-EN ISO 1043-1 PA6 GFR30
- * Segman: CK67 Yay Çeliği
- * 2: Kaplama: Krom
- 5: Kaplama: Boyalı
- 0: Kaplamasız
- * Dil (CC):Çelik

Applications

- * Electric Panels
- * Machinery Covers

Material :

- * 1: Body: Zamak
DIN-EN 1774-ZnAl4Cu1
- 35: Body: Polyamide
DIN-EN ISO 1043-1 PA6 GFR30
- * Circlip: Steel CK67
- * 2: Finish: Chrome
- 5: Finish: Black Coated
- 0: Uncoated
- * Cam (CC): Steel

Grup Kodu	Malzeme	Yüzey Kaplama	Dil Kodu	Koruma Derecesi
Group Code	Material	Finish	Cam Code	Ingress Protection Rating
KY69.K	.1	.2	.CC Diller için Sayfa:1 - Tablo: 7 For cams please check Page:1 - Table: 7	.0
	.35	.5		
	1: Zamak	2: Krom / Chrome		
		5: S. Boyalı / Black Coated		
35: Polyamide	0: Kaplamasız / Uncoated	0: Yok / No		